

WOODS

BATWING™ SLASHERS

woodsequipment.com.au

QUALITY MACHINES
BUILT FOR EFFICIENCY
AND DURABILITY



A SLASHER IS NOT JUST A SLASHER

BATWING™ SLASHERS

Table of Contents

Features & Benefits	2
12ft Batwing™ Slasher Series	3
BW12W Specifications Table.....	4
Best Batwing™ Ever	5
15ft Batwing™ Slasher Series	7
BW15.51W BW15.61QW BW15.71QRW Specifications Table.....	8
20ft Batwing™ Slasher Series	9
BW20.51QW BW20.61QW BW20.71QRW Specifications Table.....	10
Industry Leading Side Throw Series	11
Quick Reference Specifications Table	13

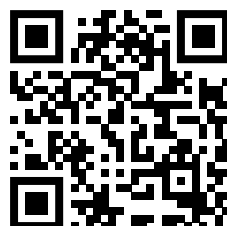

Since 1946 Woods have been manufacturing Woods Equipment in Oregon, Illinois. Woods are American made with American steel - quality machines built to last.

Woods in Australia

TISCA (Tractor Implement Supply Company of Australia Pty Ltd) have been importing Woods equipment for over 15 years. TISCA also manufactures side throw options for all Woods slashers in Australia.

Find a Woods Dealer

Woods Equipment is distributed through a network of authorised dealers. To find your nearest dealer visit us at woodsequipment.com.au or call (07) 5441 5677

So... Why Woods?

About Woods - Exclusive Features	Why Woods?
Made in USA with American Steel	Quality product, quality inputs, made to last
Change blades from above machine	Highest OH&S rating for operators for all slashers
Light hand tools required to change blades	No need for oxy, grinders or rattle guns - change blades roadside
Change blades within minutes - Quick Change Blades system	Reduction in costly downtime
4x stronger blade pin 38mm compared to 19mm bolt on standard slashers	Increased strength of blades when slashing
Greaseable blade pin	Increased longevity out of a set of blades
Built on complete subframe	Deck has increased integrity and durability in all slashing conditions
Stump jumping disc	Protect gearbox, full 360° rotation of blades to minimise impact when slashing
Does not leave a windrow	Clean distribution of material, reduced risk, efficient material management
10-year gearbox warranty	Reliable product backed by leading warranty

A SLASHER IS NOT JUST A SLASHER

WOODS EXCLUSIVE QUICK CHANGE BLADE PIN SYSTEM

Woods **Competitor**

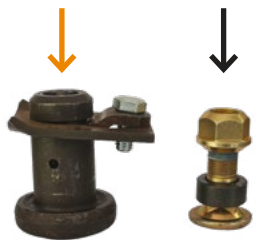

Quick Change Blade Pin System

Blade Installation Guide
Grease Nipple Lubricated

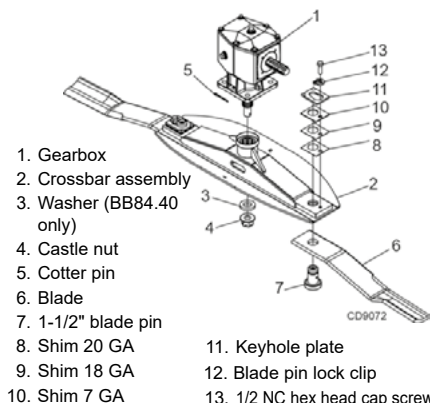

Innovation since 1946

Woods' long history of innovation began with Leonard W. Wood and his brothers. In a post-war era the Woods brothers worked together to build the first successful tractor-mounted rotary cutter and eventually founded Woods Brothers Manufacturing Co. in 1946.

Since that time, Woods has secured over 65 patents and built a global footprint in agriculture machinery with manufacturing and distribution throughout North America, Latin America and Australia. Across decades and generations, Woods had worked hard to build a reputation for innovative, high quality equipment that customers can count on year after year.

12 Foot Batwing™

Low Horsepower Flex Wing Slasher Series

The Woods Equipment BW12W Batwing™ Slasher is a low horsepower flex wing slasher. It has a 3.65m (12') cut and has a cutting capacity of 38mm diameter material. The splitter gearbox is 160hp and the spindle gearboxes are 75hp. Wings can operate at 90° up and 22° down. Wings can be operated in a vertical position allowing for slashing over banks.



DESIGNED FOR UTILITY / COMPACT TRACTORS

Requiring a minimum of 35hp, the BW12W gives you Woods quality and performance in a sleek, round-front design and our industry-leading sloped deck.

- Total weight 1,111kg with 340kg tongue weight, ideal for use on lower horsepower compact and utility tractors
- Eleven gauge, high-strength steel and smooth, sloped deck provide durability for long life
- Fully baffled deck, ensures better distribution of cut material, and the performance you expect
- Ten-year gearbox warranty including seals, for confidence in your purchase decision
- Standard chain shielding for added safety and peace of mind

Tractor PTO HP Range:
35 - 90hp

Models

BW12W | 3.65m (12')

**"WOODS ARE WELL BUILT
MACHINES."**

Mark Taylor

Orchardist & Woods Owner

SPECIFICATIONS		12FT BATWING™ SLASHER SERIES	
MODEL	BW12W		
Tractor PTO Horsepower (hp)	35hp - 90hp		
Gearbox Horsepower (hp)	160hp splitter / 75hp spindle		
Cutting Width	3.65m (12')		
Cutting Capacity	38mm		
Cutting Height Range	50mm - 300mm		
Weight	1,240kg		
Transport Width	2.4m (7.9')		
'Quick Change' Blade Pins	Yes		
Deck Design	Smooth sloped top, 11 gauge deck		
PTO RPM	540rpm		
PTO Drives	Wing drives with slip clutches		
Wing Operating Range	90° up / 22° down		
Skids	Full length replaceable "bolt on" formed side skids on wings		
Shielding	Front and rear chain shielding on wings and centre section		
Wing Hinge Pin	25mm full length		
Stump Jumper	Yes		
Access Window	Access window on top of deck for easy blade change – EXCLUSIVE FEATURE		
Blade Size	12.7mm x 101.6mm		
Hitch	Swivel Clevis Hitch		
Output Shaft	40mm		
Baffled Deck	Fully Baffled Deck		
Centre Spring	Yes		
Tip Speed	14,900fpm		
Tyres	25.5 x 8-14 foam filled severe duty ag 20ply tyres		
Number of Wheels	4		
Warranty	10-year limited gearbox warranty; 2 year deck warranty		
Options	Side Throw		

PROVEN DURABILITY

We not only build the toughest Batwing™, we build the only Batwing™.

But, don't just choose us for our name, choose us for the hours of testing in extreme conditions, the rugged sub-structure, and the industry-leading welding and paint standards.

Choose Batwing™ for the sheer ability to tame the most unruly fields, waterways, pastures and roadsides.

DURABLE CONSTRUCTION

Woods was the first to introduce a smooth, sloped deck that sheds debris.

Raising components off the deck makes clean-up easy and covering hoses protects from wear and damage.

Bolt-on, heavy-duty skid shoes with an 'approachable' leading edge reduce sod damage when turning and protect the deck from damage.

UNBEATABLE PERFORMANCE

The Batwing™ is designed with a high torque capacity, a deep deck with welded baffles, and our easy tractor hook-up so you will get to work quickly and mow more material in less time.

Woods Batwing™ cutters set the standard for cut quality, distribution and ease of use, whether you're cutting grass or shredding stalks.

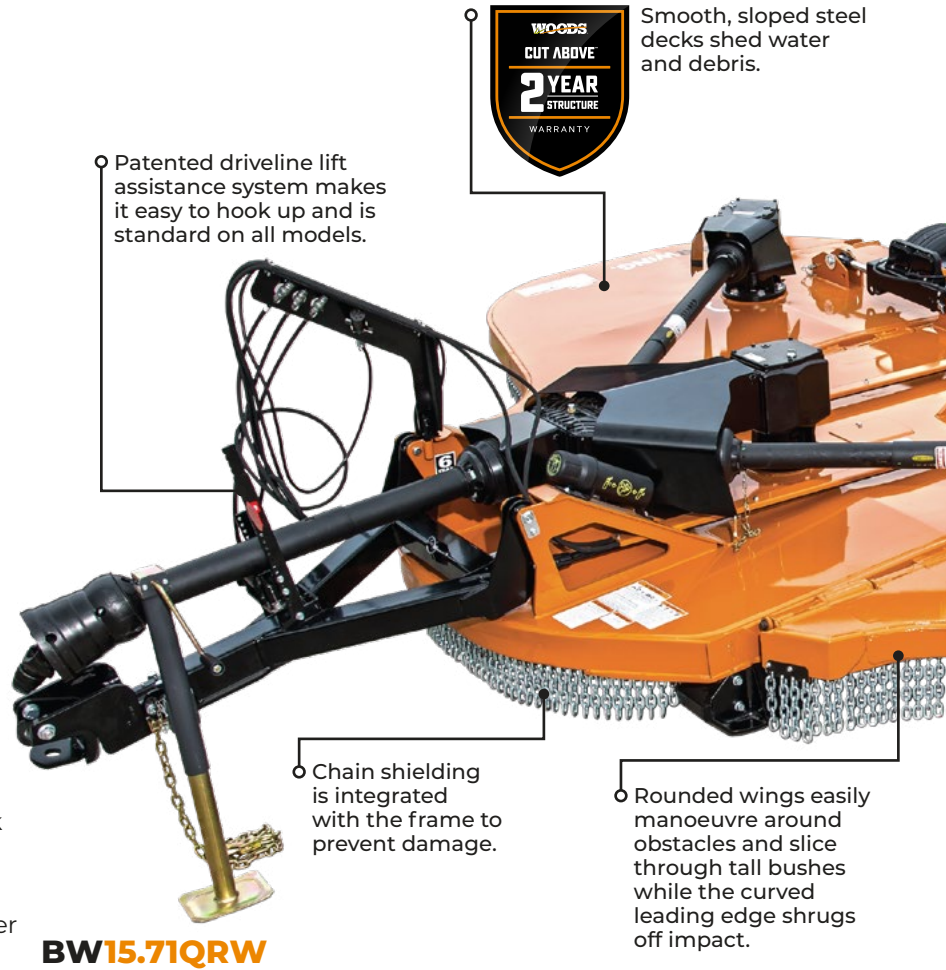

Smooth, sloped steel decks shed water and debris.

Patented driveline lift assistance system makes it easy to hook up and is standard on all models.

Chain shielding is integrated with the frame to prevent damage.

Rounded wings easily manoeuvre around obstacles and slice through tall bushes while the curved leading edge shrugs off impact.

BW15.71QRW

EASY MAINTENANCE

1. Raised components and protected hoses
2. Hinged, easy-open metal shields
3. Easy-to-reach grease fittings
4. Greaseable Quick-Change blade pins
5. Industry leading smooth, sloped deck

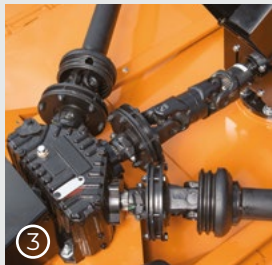

EASY TO USE

New patent-pending driveline lift assistance system makes it easy to hook up - and its stand on all models

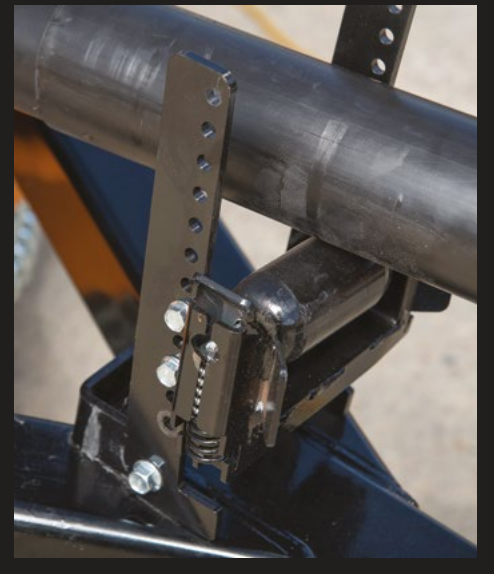



New, advanced gearbox seal technology is designed for hard conditions, reduces leaks and downtime and is backed by our ten-year gearbox warranty, which includes the seals.



Greaseable blade pins allows the blade pin to be greased to get greater longevity out of the blade carrier, reducing repairs and maintenance costs.



Change blades efficiently from above the slasher – no need to lift slasher up or for operator to be under the slasher. Reduce OH&S risk and change blades within a couple of minutes.

A steel tube around the perimeter absorbs shock and creates a stronger, longer-lasting machine.

PERFORMANCE

1. Rounded Wings
2. Curved Leading Edge
3. Calculated positioning of welded baffles



RELIABILITY



New, advanced gearbox seal technology, designed for harsh conditions, reduces leaks and downtimes and is backed by our ten-year gearbox warranty - which includes the seals.



DURABILITY



1. Steel tube frame absorbs shock
2. Integrated chain shielding prevents damage
3. Heavy-duty skid shoes



THE BEST BATWING™ YOU EVER DESIGNED.

15 Foot Batwing™

Standard, Heavy & Extreme Heavy-Duty 15ft Flex Wing Slasher Series

The Woods Equipment BW15 Series Batwing™ Slashers are ideal for cutting tall grasses and saplings up to 65mm (2½") in diameter. The BW15.61QW easily powers through tall bushes and trees up to 100mm (4") in diameter, while the rugged BW15.71QRW can tame the harshest conditions, ideal for professional and contract slashing.



Tractor PTO HP Range:
45 - 180hp

Models

BW15.51W | 4.57m (15')

- Standard Duty Slasher
- Main driveline: Cat 6 CV
- Cuts bushes up to 65mm (2½") in diameter
- Walking Tandem axle available
- Optional Dual Wheels in centre

Tractor PTO HP Range:
75 - 250hp

Models

BW15.61QW | 4.57m (15')

- Heavy Duty Slasher
- Main driveline: Cat 6 CV
- Cuts bushes up to 100mm (4") in diameter
- Side frame depth of 336mm (13.25") - **deepest in the industry**
- Optional Walking Tandem Beam
- Optional Shredding Kit

Tractor PTO HP Range:
80 - 250hp

Models

BW15.71QRW | 4.57m (15')

- Extreme Heavy Duty Slasher
- Main driveline: Cat 6 CV
- Cuts bushes up to 115mm (4½") in diameter
- Side frame depth of 317mm (12.5")
- Walking Beam Suspension standard in centre deck, optional on outer wings
- Optional Shredding Kit

A SLASHER IS NOT JUST A SLASHER

SPECIFICATIONS			
15FT BATWING™ SLASHER SERIES			
MODEL	BW15.51W	BW15.61QW	BW15.71QRW
Tractor PTO Horsepower (hp)	45hp - 180hp	75hp - 250hp	80hp - 250hp
Gearbox Horsepower (hp)	210hp splitter / 200hp spindle	275hp splitter / 225hp spindle	
Cutting Width	4.57m (15')		
Cutting Capacity	65mm	100mm	115mm
Cutting Height Range	50mm - 380mm		
Weight	2,160kg	2,430kg	2,795kg
Transport Width	2.4m (7.9')		
'Quick Change' Blade Pins	Yes		
Deck Design	Industry leading smooth, sloped 4mm deck	Industry leading smooth, sloped 5mm deck	Industry leading smooth, sloped 6mm deck
PTO RPM	540rpm	1,000rpm	
PTO Drives	Cat 6 CV input PTO drive with Driveline lift assistance		
Deck Drives	Cat 4 deck drives with 2 plate slip clutches		Cat 5 deck drives with 4 plate slip clutches
Wing Operating Range	90° up / 22° down, Rounded wings with curved leading edge		
Skids	Heavy duty replaceable "bolt-on" formed side skids on wings		
Shielding	Integrated chain shielding to prevent damage		
Wing Hinge Pin	25mm full length		
Stump Jumper	Yes		
Access Window	Access window on top of deck for easy blade change – EXCLUSIVE FEATURE		
Blade Size	12.7mm x 101.6mm		
Hitch	Swivel Clevis Hitch		
Output Shaft	50.8mm	76.2mm	
Centre Spring	No		
Axle Arms	Axle springs		Axle springs and walking tandem beam in centre deck
Tip Speed	15,000 / 16,000fpm blade tip speed for 540 / 1,000rpm PTO	15,700 / 16,000fpm blade tip speed for 540 / 1,000rpm PTO	
Tyres	25.5 x 8-14 foam filled severe duty ag 20ply tyres		
Number of Wheels	4	6	
Warranty	10 year limited gearbox warranty; 2 year deck warranty		
Options	Dual Wheels on wings, LED Lights	Dual Wheels on wings, LED Lights, Shredding kit, Walking Tandem Beams	Deck Ring (Standard), Dual Wheels on wings, LED Lights, Shredding kit, Walking Tandem Beams on Wings

20 Foot Batwing™

Standard, Heavy & Extreme Heavy-Duty 20ft Flex Wing Slasher Series

Designed for tractors up to 275hp tractor PTO horsepower with a cutting capacity that varies between the series: standard-duty can cut up to 50mm (2") diameter material, the heavy-duty cuts 75mm (3") diameter material and the extreme heavy-duty cuts up to 100mm (4") diameter material. The 20ft Batwing™ series is perfect for large acreage slashing and crop stubble slashing. Single or double side throw option available.



Tractor PTO HP Range:
70 - 200hp

Models

BW20.51QW | 6.3m (20')

- Standard Duty Slasher
- Main driveline: Cat 6 CV
- Cuts bushes up to 50mm (2") in diameter
- Walking Tandem axle available

Tractor PTO HP Range:
70 - 275hp

Models

BW20.61QW | 6.3m (20')

- Heavy Duty Slasher
- Main driveline: Cat 6 CV
- Cuts bushes up to 75mm (3") in diameter
- Side frame depth of 336mm (13.25") - the deepest in the industry
- Optional Shredding Kit

Tractor PTO HP Range:
70 - 275hp

Models

BW20.71QRW | 6.3m (20')

- Extreme Heavy Duty Slasher
- Main driveline: Cat 6 CV
- Cuts bushes up to 100mm (4") in diameter
- Side frame depth of 317mm (12.5")
- Optional Shredding Kit

**WE NOT ONLY BUILD THE
TOUGHEST BATWING™, WE BUILD
THE ONLY BATWING™**

SPECIFICATIONS		20FT BATWING™ SLASHER SERIES		
MODEL	BW20.51QW	BW20.61QW	BW20.71QRW	
Tractor PTO Horsepower (hp)	70hp - 200hp	70hp - 275hp		
Gearbox Horsepower (hp)	250hp splitter / 200hp spindle	275hp splitter / 225hp spindle		
Cutting Width	6.3m (20')			
Cutting Capacity	50mm	75mm	100mm	
Cutting Height Range	50mm - 380mm			
Weight	3,050kg	3,680kg	4,120kg	
Transport Width	3.05m (10')			
'Quick Change' Blade Pins	Yes			
Deck Design	Smooth sloped 3.5mm deck		Smooth sloped 7mm deck	
PTO RPM	1,000rpm			
PTO Drives	Heavy wide-angle input PTO drive			
Deck Drives	Series 4 deck drives with 2 plate slip clutches		Series 6 deck drives with 4 plate slip clutches	
Wing Operating Range	Floating linkage on wing lift cylinders 90° up / 22° down			
Skids	Full length replaceable "bolt on" formed side skids on wings			
Shielding	Front and rear chain shielding on wings and centre section			
Wing Hinge Pin	25mm full length			
Stump Jumper	Yes			
Access Window	Access window on top of deck for easy blade change – EXCLUSIVE FEATURE			
Blade Size	12.7mm x 101.6mm			
Hitch	Swivel Clevis Hitch			
Output Shaft	50.8mm	76.2mm		
Baffled Deck	Fully Baffled Deck			
Centre Spring	No			
Axle Arms	Spring loaded axle arms	Walking tandem spring loaded axle arms		
Tip Speed	16,300fpm blade tip speed for 1,000rpm PTO			
Tyres	25.5 x 8-14 foam filled severe duty ag 20ply tyres			
Number of Wheels	6	8		
Warranty	10 year limited gearbox warranty; 2 year deck warranty			
Options	Walking Tandem Beams , Dual Wheels on Wings		Shredding Kit	

Side Throw Series

Single Spindle Side Throw Series

The Woods Side Throw Batwing™ Slasher Series is perfect for any side throw applications, particularly in orchards where the control of discharge aids mulching under trees.

Tried and tested in orchards and paddocks across Australia, the Woods Side Throw slasher is designed to work and its results make it the industry leader for side throw slashers.

- Material won't choke up under machine
- Controlled discharge via adjustable chute
- Throw adjustable to suit variety of row widths
- Won't gouge ground

MDS8.50W

Side Throw available on all models

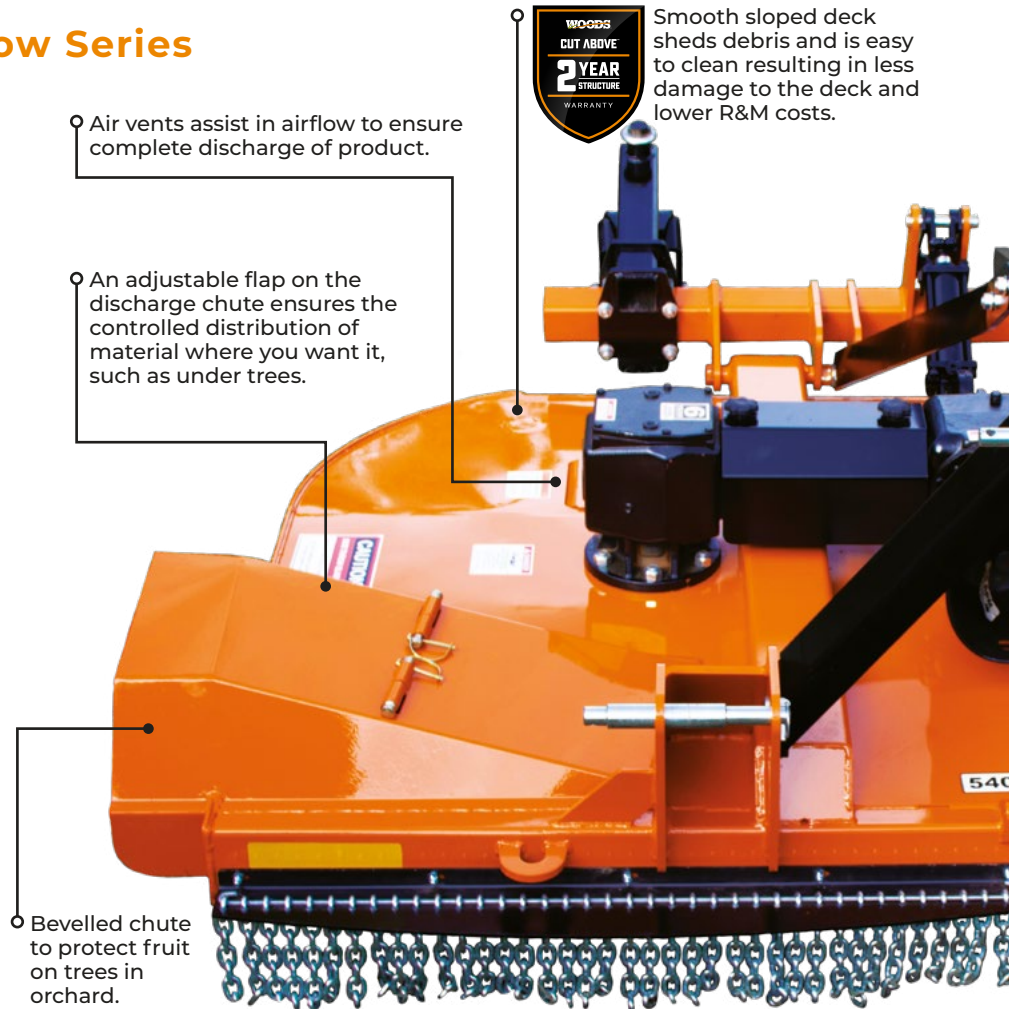

WHY ARE WOODS SIDE THROWS INDUSTRY LEADERS IN AUSTRALIA?



Quick change blade pins

Quick Change blade pin system allows operator to change blades efficiently from above machine within a couple of minutes with light hand tools – no oxy required.



High Throw Blade

The high throw blade will discharge material with total clearance so material does not block up machine.



Adjustable Flap

An adjustable flap on the discharge chute ensures the controlled distribution of material where you want it, such as under trees.



Air Vents

Air vents assist in airflow to ensure complete discharge of product.



New, advanced gearbox seal technology is designed for hard conditions, reduces leaks and downtime and is backed by our ten-year gearbox warranty, which includes the seals.



Change blades efficiently from above the slasher – no need to lift slasher up or for operator to be under the slasher. Reduce OH&S risk and change blades within a couple of minutes.

The high throw blade will discharge material with total clearance so material does not block up machine.

Bevelled skids will not gouge the ground.

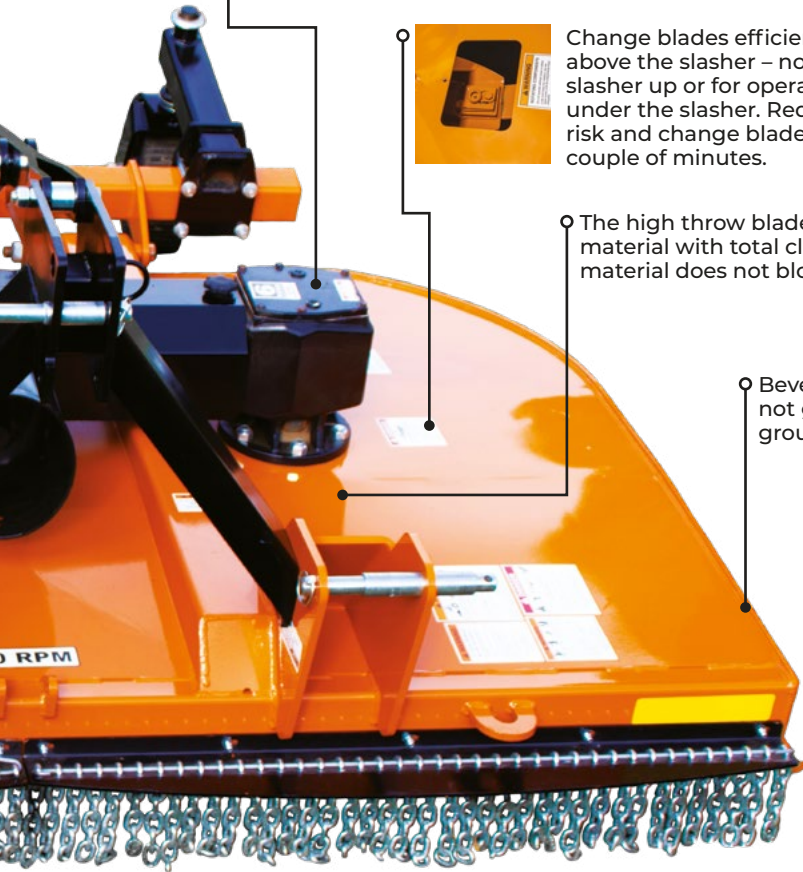

BENEFITS OF A WOODS SIDE THROW SLASHER

- Adjustable flap controls discharge to allow mulching under trees and increase efficiency of production and reduce erosion
- Air vent and high lift blades ensure complete discharge of material
- Deck design ensures slasher will not leave a windrow for efficient grass management

A SLASHER IS NOT JUST A SLASHER

"EVEN WHEN SLASHING IN HEAVY MATERIAL NOTHING IS LEFT BEHIND, GIVING MY ORCHARD A MOWER FINISH AND NICELY DISCHARGING MATERIAL UNDER MY TREES."

Mark Taylor

Orchardist & Woods Owner

SPECIFICATIONS

MODEL	BW12W	BW15.51W	BW15.61QW
Tractor PTO Horsepower	35hp - 90hp	45hp - 180hp	75hp - 250hp
Gearbox Horsepower	160hp splitter / 75hp spindle	210hp splitter / 200hp spindle	275hp splitter
Cutting Width	3.65m (12')		4.57m (15')
Cutting Capacity	38mm	65mm	100mm
Cutting Height Range	50mm - 300mm		
Weight	1,240kg	2,160kg	2,430kg
Transport Width	2.4m (7.9')		
'Quick Change' Blade Pins			
Deck Design	Smooth sloped 2.9mm deck	Industry leading smooth, sloped 4.1mm deck	Industry leading smooth, sloped 5mm deck
PTO RPM	540rpm		
PTO Drives	Wing drives with slip clutches	Cat 6 CV input PTO drive with Driveline li	
Deck Drives	Cat 4 deck drives with 2 plate slip clutches		
Wing Operating Range	90° up / 22° down	90° up / 22° down, Rounded wings with curv	
Skids	Full length replaceable "bolt on" formed side skids on wings	Heavy duty replaceable "bolt-on" formed side	
Shielding	Front and rear chain shielding on wings and centre section	Integrated chain shielding to prevent	
Wing Hinge Pin			
Stump Jumper			
Access Window	Access window on top		
Blade Size			
Hitch			
Baffled Deck	Fully Baffled Deck		
Output Shaft	40mm	50.8mm	76.
Centre Spring	Yes		
Axle Arms	Axle springs		
Tip Speed	14,900fpm	15,000 / 16,000fpm blade tip speed for 540 / 1,000rpm PTO	15,700 / 16,000fpm blade tip
Tyres	25.5 x 8		
Number of Wheels	4		
Warranty	10 year lim		
Options	Side Throw	Dual Wheels on wings / LED Lights	Dual Wheels on wings / LED Lights / Shredding kit / Walking Tandem Beams

BLATWING™ SLASHER SERIES

BW15.71QRW	BW20.51QW	BW20.61QW	BW20.71QRW
80hp - 250hp	70hp - 200hp	70hp - 275hp	
/ 225hp spindle	250hp splitter / 200hp spindle	275hp splitter / 225hp spindle	
50mm - 380mm		6.3m (20')	
115mm	50mm	75mm	100mm
2,795kg	3,050kg	3,680kg	4,120kg
Yes		3.05m (10')	
Industry leading smooth, sloped 6mm deck	Smooth sloped 3.5mm deck		Smooth sloped 7mm deck
1,000rpm		Heavy wide-angle input PTO drive	
ft assistance	Series 4 deck drives with 2 plate slip clutches		Series 6 deck drives with 4 plate slip clutches
Cat 5 deck drives with 4 plate slip clutches	Floating linkage on wing lift cylinders 90° up / 22° down		
ed leading edge	Full length replaceable "bolt on" formed side skids on wings		
e skids on wings	Front and rear chain shielding on wings and centre section		
damage	25mm full length		
Yes			
o of deck for easy blade change – EXCLUSIVE FEATURE			
12.7mm x 101.6mm			
Swivel Clevis Hitch			
		Fully Baffled Deck	
2mm	50.8mm	76.2mm	
No			
Axle springs and walking tandem beam in centre deck	Spring loaded axle arms	Walking tandem spring loaded axle arms	
speed for 540 / 1,000rpm PTO	16,300fpm blade tip speed for 1,000rpm PTO		
-14 foam filled severe duty ag 20ply tyres			
6		8	
ited gearbox warranty; 2 year deck warranty			
Deck Ring (Standard) / Dual Wheels on wings / LED Lights / Shredding kit / Walking Tandem Beams on Wings	Walking Tandem Beams / Dual Wheels on Wings	Shredding Kit	



1137 Nambour Connection Rd, Parklands QLD 4560

(07) 5441 5677

woodsequipment.com.au
tisca.com.au

WOODS

Warning! Some images may show safety shields removed to provide a better view. Equipment should never be operated with any safety shield removed. Some machines in this brochure may be shown with optional equipment. Always operate machines in accordance with supplied operator's manuals. ©2024 Woods Equipment Company. All rights reserved. WOODS and Woods logo are trademarks of Woods Equipment Company. All other trademarks, trade names, or service marks not owned by Woods Equipment Company that appear in this brochure are the property of their respective companies or mark holders. Specifications subject to change without notice.